

Rea

ŁAZIENKA Z WYOBRAŻNIĄ

INSTRUKCJA MONTAŻU

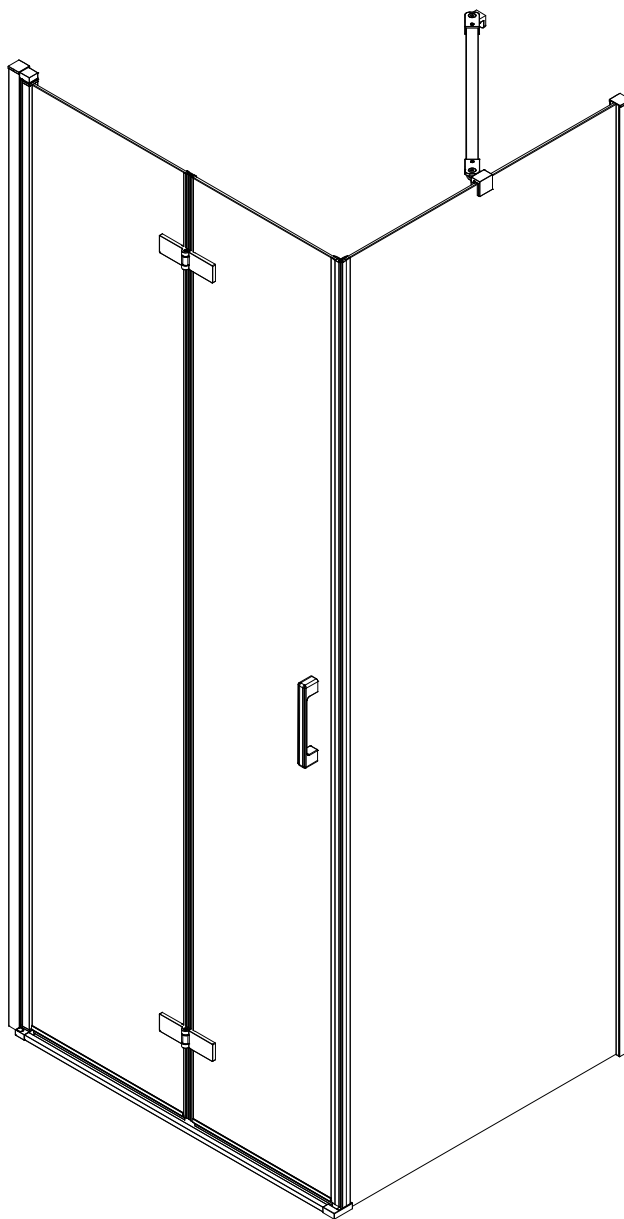

KABINA PRYSZNICOWA
MOLIER

1. Uwagi dotyczące montażu

Przed rozpoczęciem montażu prosimy sprawdzić czy wszystkie elementy zawarte w instrukcji znajdują się w opakowaniu oraz czy nie są uszkodzone. W przypadku uszkodzeń lub braków prosimy o pilny kontakt ze sprzedawcą.

UWAGA: NIE MONTOWAĆ ELEMENTÓW USZKODZONYCH

- Przed rozpoczęciem montażu proszę zapoznać się z instrukcją, proszę sprawdzić czy ma się wymagane narzędzia i elementy składowe kabiny. Należy postępować zgodnie z instrukcją.
- Proszę nie używać ostrych ani twardych narzędzi podczas montażu, aby uniknąć uszkodzenia szyb. W razie potrzeby należy użyć gumowego młotka.

2. Potrzebne narzędzia (nie ma w zestawie):

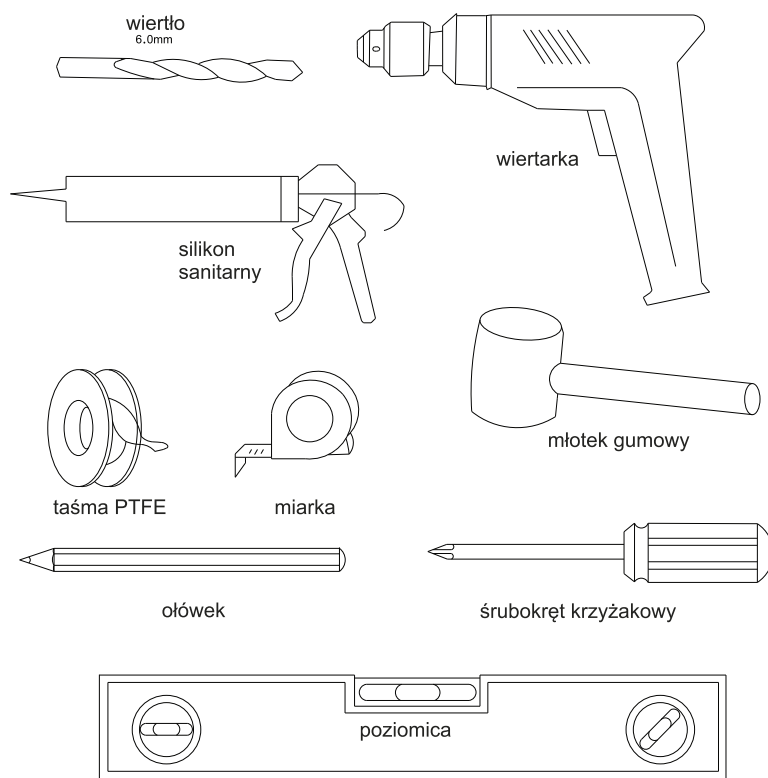

3. UWAGA!

- Osoby, które czują się słabo lub są po spożyciu alkoholu nie powinny korzystać z kabiny.
- Osoby cierpiące na choroby serca i wysokie ciśnienie powinny być szczególnie ostrożne w czasie korzystania z kabiny.
- Dzieci i osoby starsze powinny korzystać z kabiny pod nadzorem osób dorosłych.
- Proszę zachować szczególną ostrożność w czasie wchodzenia i wychodzenia z kabiny. Aby uniknąć uszkodzeń kabiny i utraty równowagi proszę nie opierać się o ścianę.
- Czas kąpieli proszę dostosowywać do samopoczucia.
- Zabrania się odkręcania jedynie wody gorącej w czasie dostosowywania temperatury wody.
- Zabrania się palić w kabinie.

4. Czyszczenie i konserwacja

- Codzienne czyszczenie może być wykonywane za pomocą zwykłych środków czystości i miękkiej szmatki. Nie wskazane jest używanie środków bazujących na acetonie i amoniaku.
- Zacieki mogą być usuwane przy pomocy octu.
- Po czyszczeniu proszę zostawić drzwi otwarte, aby szybciej wyschły.

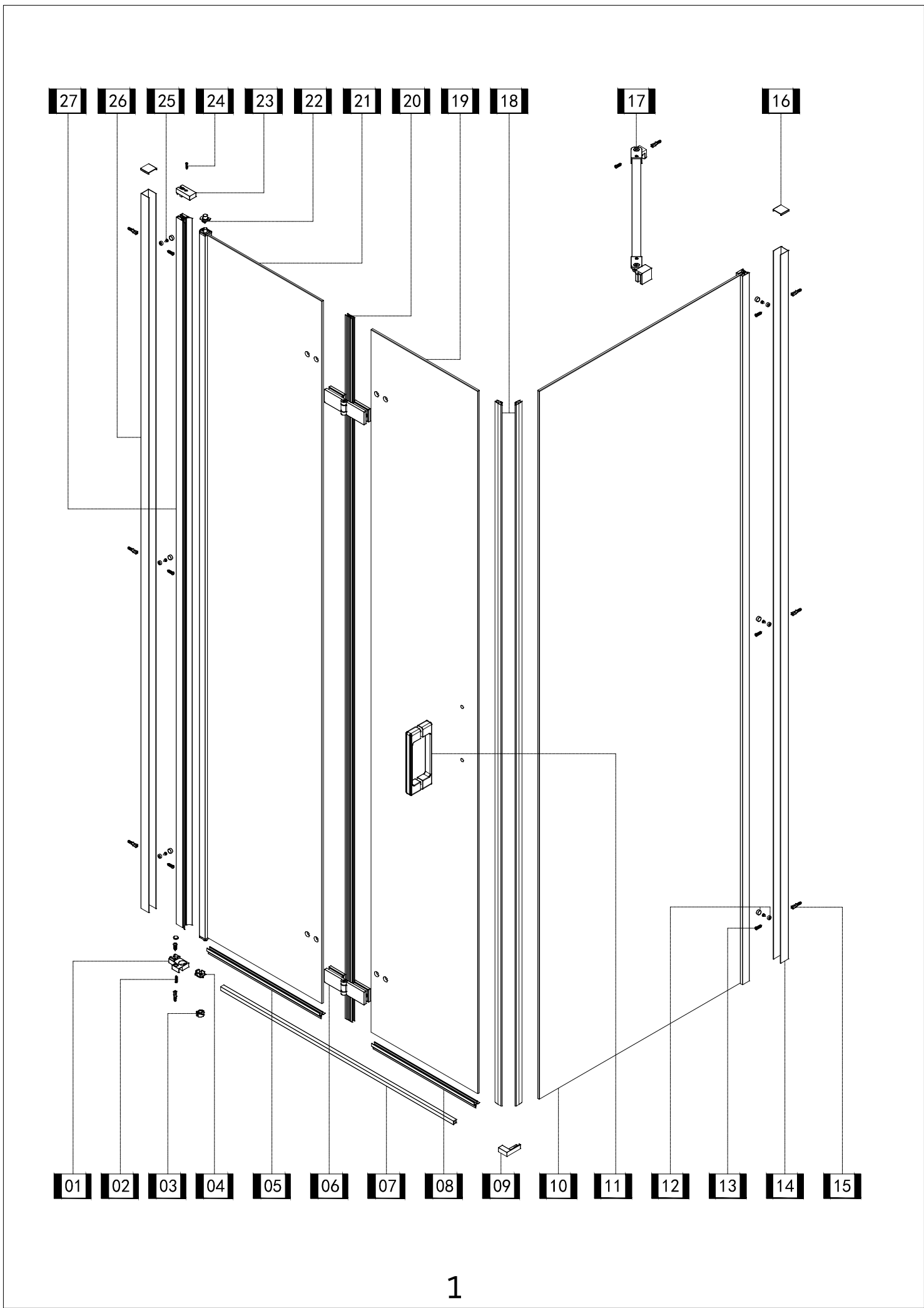

CZĘŚCI

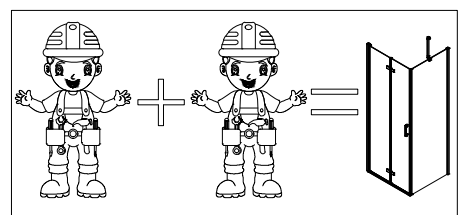
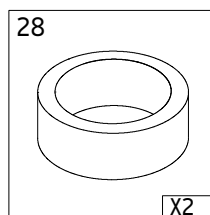
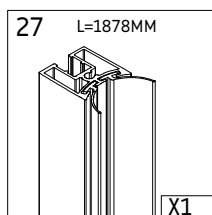
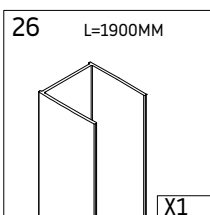
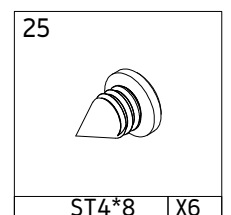
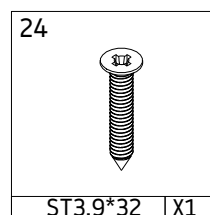
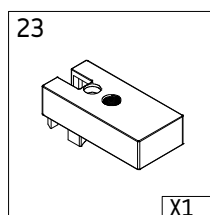
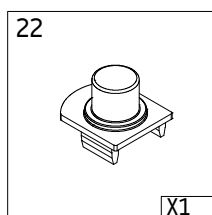
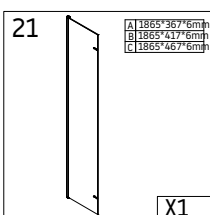
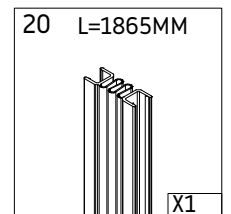
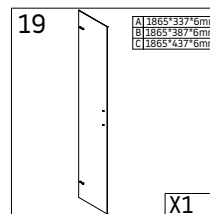
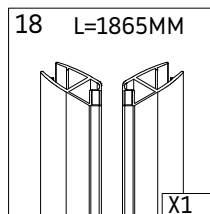
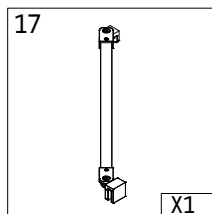
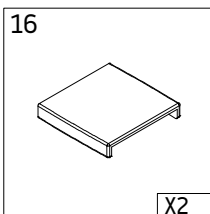
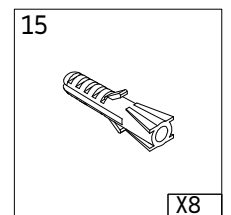
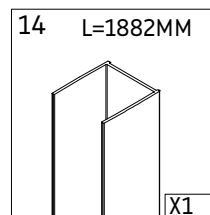
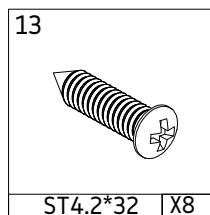
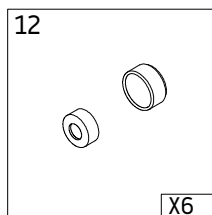
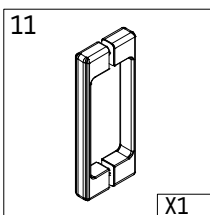
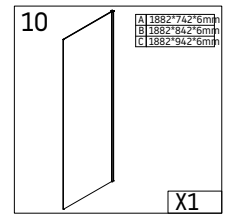
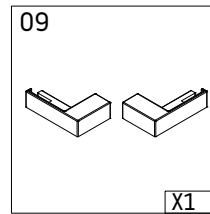
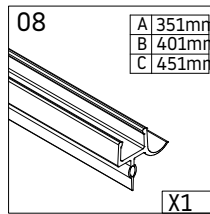
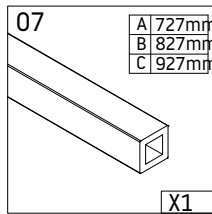
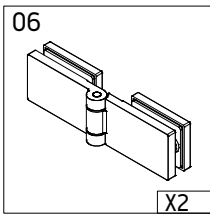
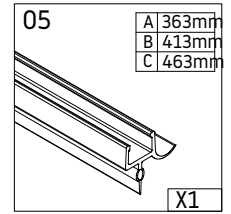
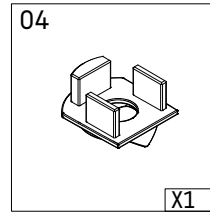
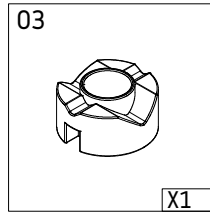
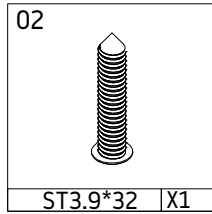
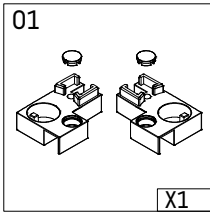

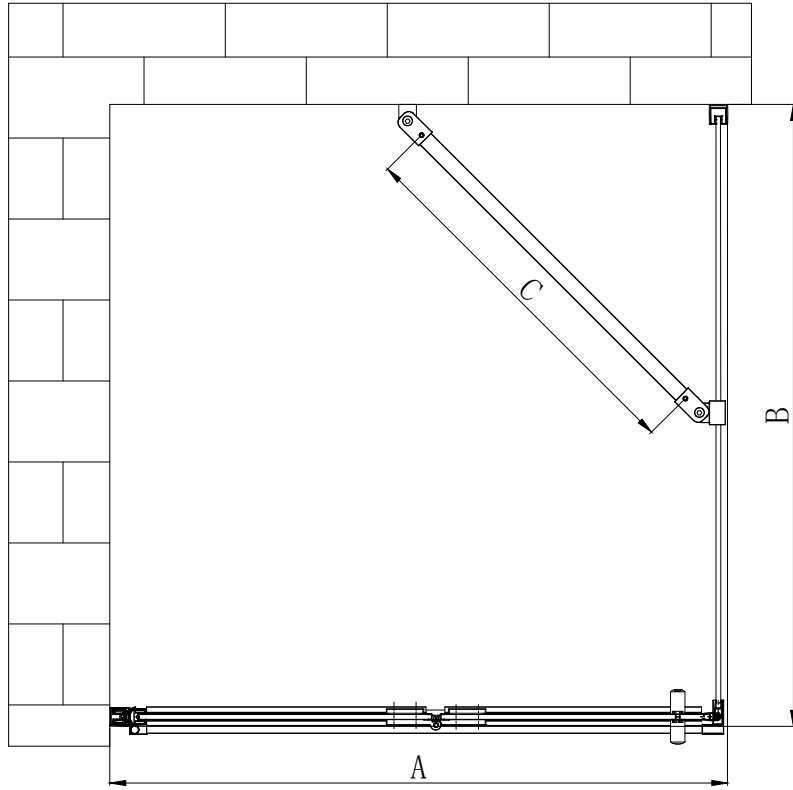

A	B	C
775-785	780-790	495-505
875-885	880-890	495-505
975-985	980-990	495-505

