

Rea

ŁAZIENKA Z WYOBRAŹNIĄ

INSTRUKCJA MONTAŻU

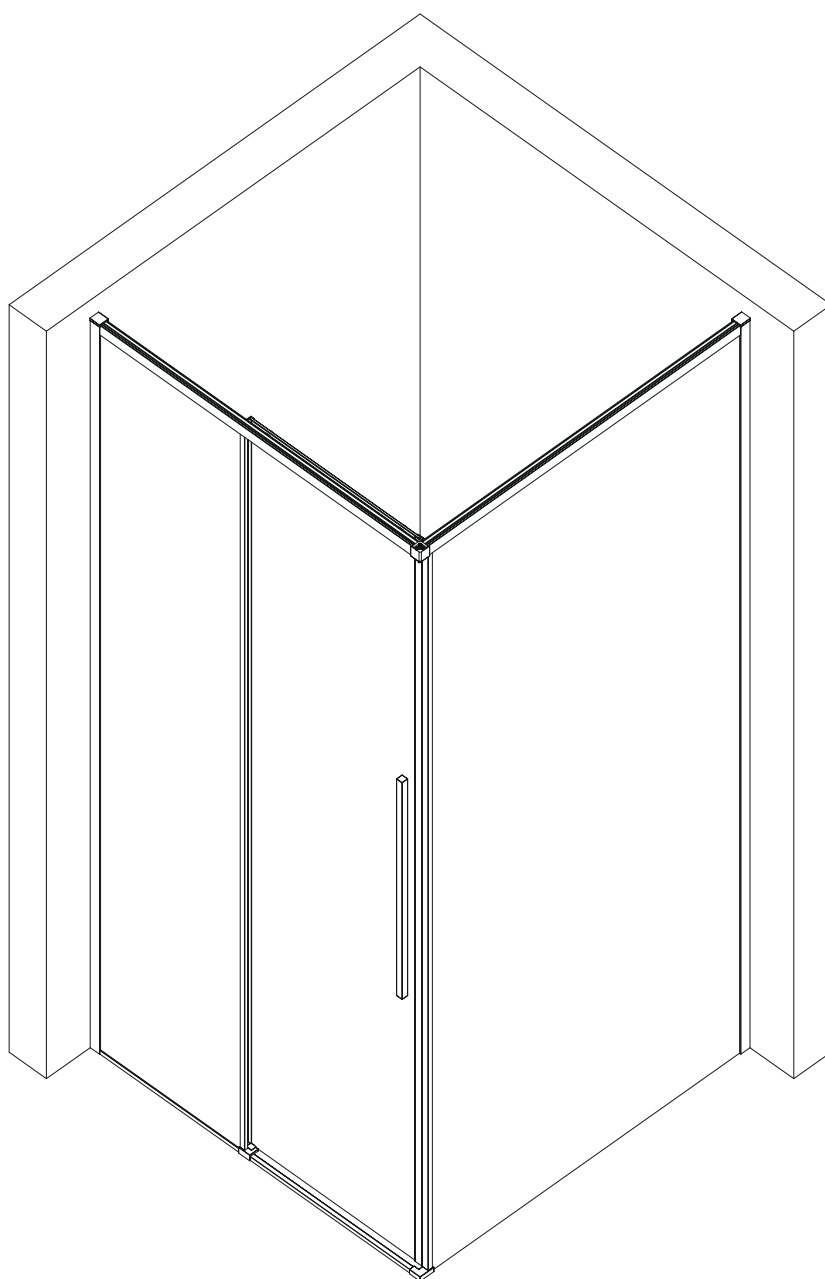

KABINA SOLAR

1. Uwagi dotyczące montażu

Przed rozpoczęciem montażu prosimy sprawdzić czy wszystkie elementy zawarte w instrukcji znajdują się w opakowaniu oraz czy nie są uszkodzone. W przypadku uszkodzeń lub braków prosimy o pilny kontakt ze sprzedawcą.

UWAGA: NIE MONTOWAĆ ELEMENTÓW USZKODZONYCH

- Przed rozpoczęciem montażu proszę zapoznać się z instrukcją, proszę sprawdzić czy ma się wymagane narzędzia i elementy składowe kabiny. Należy postępować zgodnie z instrukcją.
- Proszę nie używać ostrych ani twardych narzędzi podczas montażu, aby uniknąć uszkodzenia szyb. W razie potrzeby należy użyć gumowego młotka.

2. Potrzebne narzędzia (nie ma w zestawie):

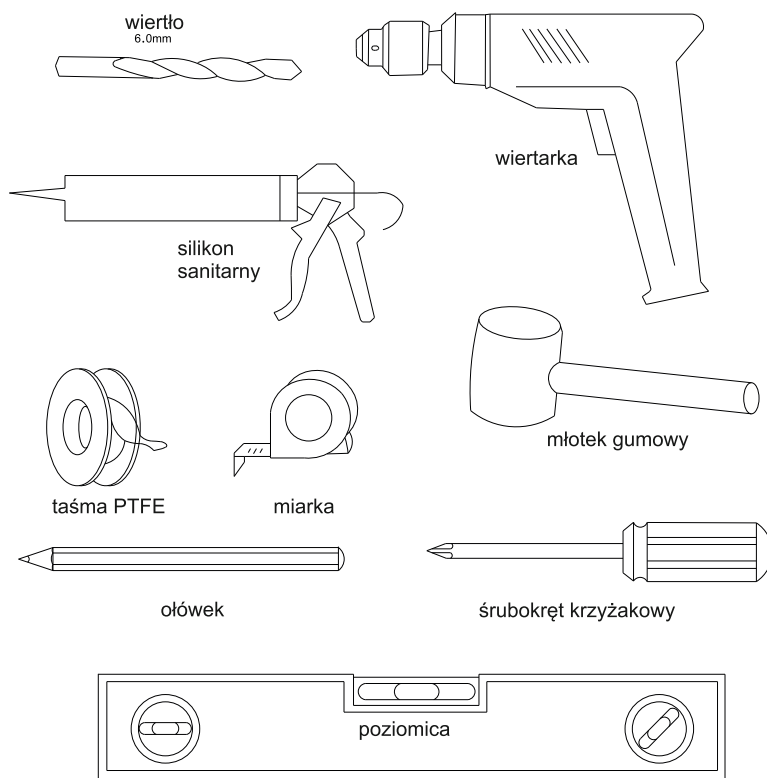

3. UWAGA!

- Osoby, które czują się słabo lub są po spożyciu alkoholu nie powinny korzystać z kabiny.
- Osoby cierpiące na choroby serca i wysokie ciśnienie powinny być szczególnie ostrożne w czasie korzystania z kabiny.
- Dzieci i osoby starsze powinny korzystać z kabiny pod nadzorem osób dorosłych.
- Proszę zachować szczególną ostrożność w czasie wchodzenia i wychodzenia z kabiny. Aby uniknąć uszkodzeń kabiny i utraty równowagi proszę nie opierać się o ścianę.
- Czas kąpieli proszę dostosowywać do samopoczucia.
- Zabrania się odkręcania jedynie wody gorącej w czasie dostosowywania temperatury wody.
- Zabrania się palić w kabinie.

4. Czyszczenie i konserwacja

- Codzienne czyszczenie może być wykonywane za pomocą zwykłych środków czystości i miękkiej szmatki. Nie wskazane jest używanie środków bazujących na acetonie i amoniaku.
- Zacieki mogą być usuwane przy pomocy octu.
- Po czyszczeniu proszę zostawić drzwi otwarte, aby szybciej wyschły.

1. Uwagi dotyczące montażu

Przed rozpoczęciem montażu prosimy sprawdzić czy wszystkie elementy zawarte w instrukcji znajdują się w opakowaniu oraz czy nie są uszkodzone. W przypadku uszkodzeń lub braków prosimy o pilny kontakt ze sprzedawcą.

UWAGA: NIE MONTOWAĆ ELEMENTÓW USZKODZONYCH

- Przed rozpoczęciem montażu proszę zapoznać się z instrukcją, proszę sprawdzić czy ma się wymagane narzędzia i elementy składowe kabiny. Należy postępować zgodnie z instrukcją.
- Proszę nie używać ostrych ani twardych narzędzi podczas montażu, aby uniknąć uszkodzenia szyb. W razie potrzeby należy użyć gumowego młotka.

2. Potrzebne narzędzia (nie ma w zestawie):

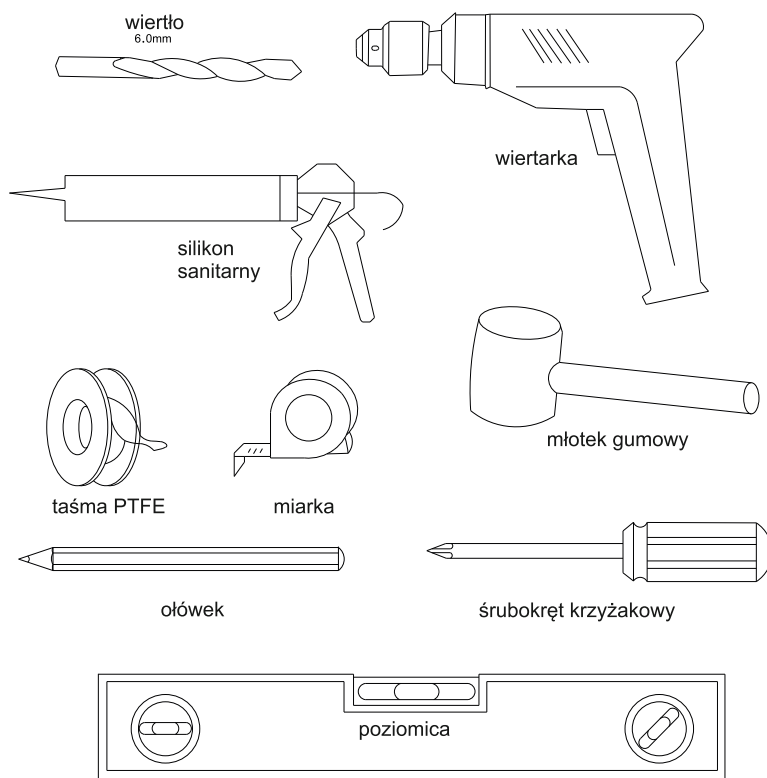









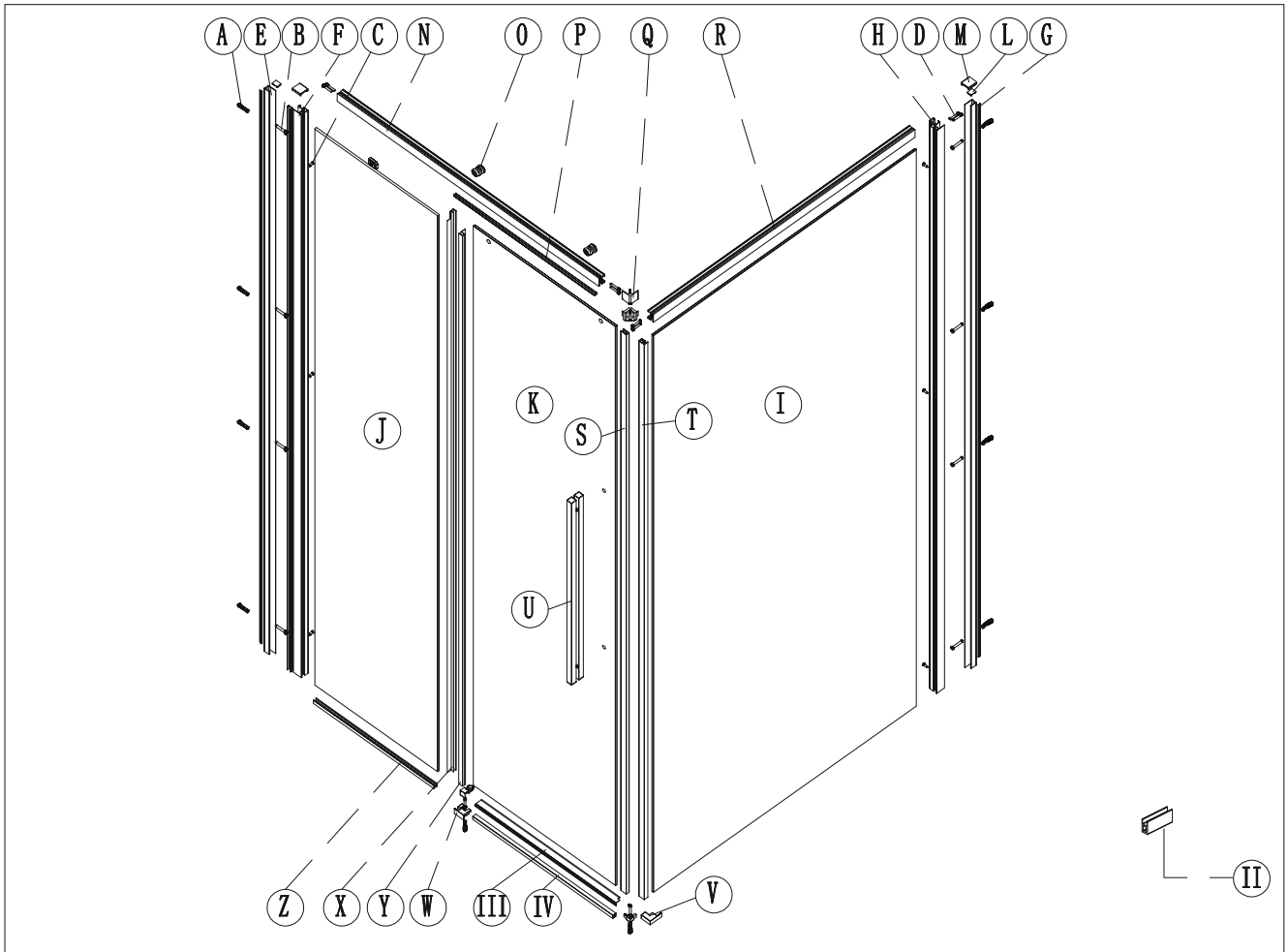

















































3. UWAGA!

- Osoby, które czują się słabo lub są po spożyciu alkoholu nie powinny korzystać z kabiny.
- Osoby cierpiące na choroby serca i wysokie ciśnienie powinny być szczególnie ostrożne w czasie korzystania z kabiny.
- Dzieci i osoby starsze powinny korzystać z kabiny pod nadzorem osób dorosłych.
- Proszę zachować szczególną ostrożność w czasie wchodzenia i wychodzenia z kabiny. Aby uniknąć uszkodzeń kabiny i utraty równowagi proszę nie opierać się o ścianę.
- Czas kąpieli proszę dostosowywać do samopoczucia.
- Zabrania się odkręcania jedynie wody gorącej w czasie dostosowywania temperatury wody.
- Zabrania się palić w kabinie.

4. Czyszczenie i konserwacja

- Codzienne czyszczenie może być wykonywane za pomocą zwykłych środków czystości i miękkiej szmatki. Nie wskazane jest używanie środków bazujących na acetonie i amoniaku.
- Zacieki mogą być usuwane przy pomocy octu.
- Po czyszczeniu proszę zostawić drzwi otwarte, aby szybciej wyschły.



 X10	 ST4. 2x32 X8	 ST3. 5x9. 5 X6	 ST3. 9x32 X8	 X2	 X2	 X2	 X2
 X1	 X1	 X1	 X2	 X2	 X1	 X2	 X1
 q1 q2 X1	 X1	 X1	 X1	 X1	 v1 v2 X1	 v1 v2 X1	 X1
 X1	 X1	 X2	 X1	 X1			
 X1	 X1	 X2	 X1	 X1			
 X1	 X1	 X2	 X1	 X1	 X1	 X1	 X1
 X1	 X1	 X2	 X1	 X1	 X1	 X1	 X1
 X1	 X1	 X2	 X1	 X1	 X1	 X1	 X1

